

# Technical Data Sheet

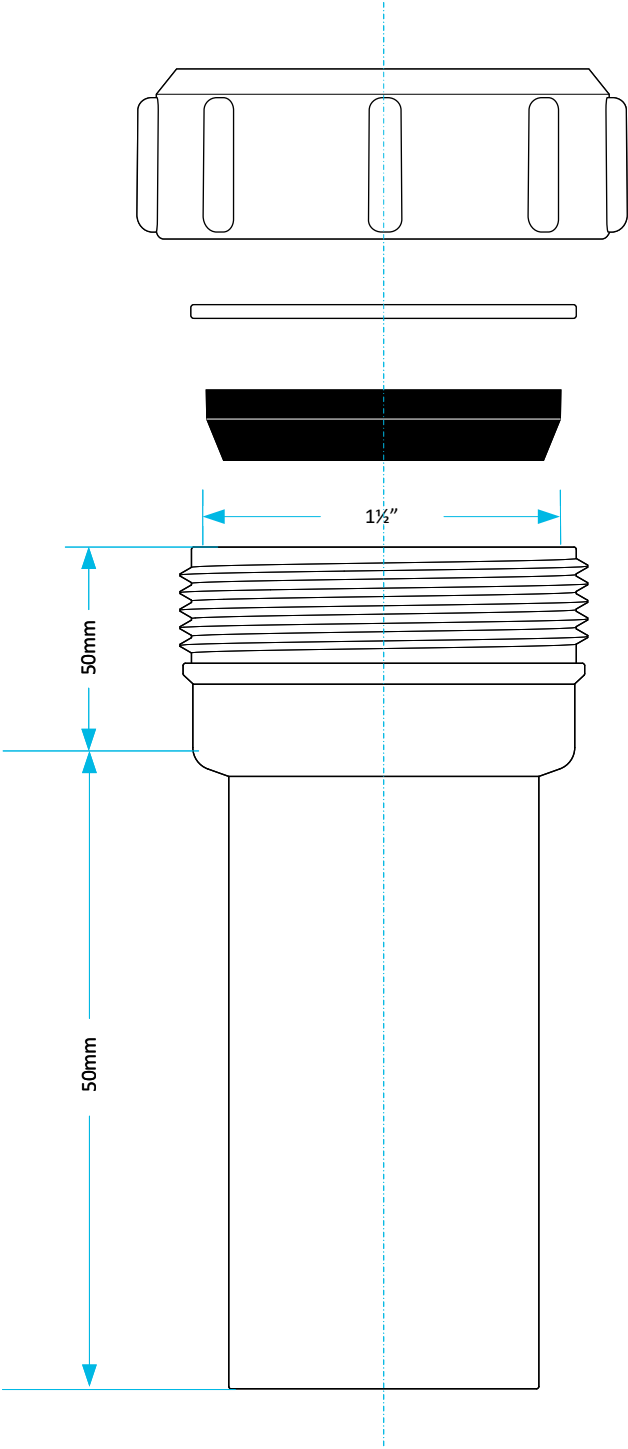

CODE:

W40L

DESCRIPTION:

1 1/2" Straight Compression x Plain End Connector

CATEGORY:

Waste Fittings



Viva Sanitary  
01/08/2025

DRAWN BY:

RH

VERIFIED BY:

AH